

FEATURES

- isoPower* integrated, isolated dc-to-dc converter
- Regulated 3.3 V or 5.0 V output
- Up to 500 mW output power
- Quad dc-to-25 Mbps (NRZ) signal isolation channels
- 16-lead SOIC package with 7.6 mm creepage
- High temperature operation: 105°C maximum
- High common-mode transient immunity: >25 kV/μs
- Safety and regulatory approvals**
 - UL recognition
 - 2500 V rms for 1 minute per UL 1577
 - CSA Component Acceptance Notice 5A
 - VDE certificate of conformity
 - IEC 60747-5-2 (VDE 0884, Part 2)
 - V_{IORM} = 560 V peak

APPLICATIONS

- RS-232/RS-422/RS-485 transceivers
- Industrial field bus isolation
- Power supply start-up bias and gate drives
- Isolated sensor interfaces
- Industrial PLCs

GENERAL DESCRIPTION

The ADuM5401/ADuM5402/ADuM5403/ADuM5404¹ are quad-channel digital isolators with *isoPower*[®], an integrated, isolated dc-to-dc converter. Based on the Analog Devices, Inc., *iCoupler*[®] technology, the dc-to-dc converter provides up to 500 mW of regulated, isolated power at either 5.0 V or 3.3 V from a 5.0 V input supply, or at 3.3 V from a 3.3 V supply at the power levels shown in Table 1. These devices eliminate the need for a separate, isolated dc-to-dc converter in low power, isolated designs. The *iCoupler* chip scale transformer technology is used to isolate the logic signals and for the power and feedback paths in the dc-to-dc converter. The result is a small form factor, total isolation solution.

The ADuM5401/ADuM5402/ADuM5403/ADuM5404 isolators provide four independent isolation channels in a variety of channel configurations and data rates (see the Ordering Guide for more information).

isoPower uses high frequency switching elements to transfer power through its transformer. Special care must be taken during printed circuit board (PCB) layout to meet emissions standards. See the AN-0971 Application Note for board layout recommendations.

¹ Protected by U.S. Patents 5,952,849; 6,873,065; 6,903,578; and 7,075,329. Other patents are pending.

Rev. D

[Document Feedback](#)

Information furnished by Analog Devices is believed to be accurate and reliable. However, no responsibility is assumed by Analog Devices for its use, nor for any infringements of patents or other rights of third parties that may result from its use. Specifications subject to change without notice. No license is granted by implication or otherwise under any patent or patent rights of Analog Devices. Trademarks and registered trademarks are the property of their respective owners.

FUNCTIONAL BLOCK DIAGRAMS

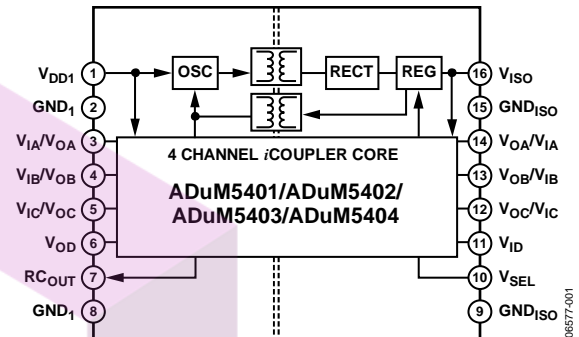

Figure 1.

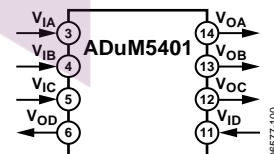

Figure 2. ADuM5401

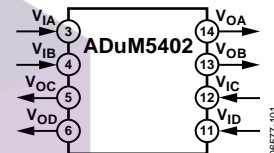

Figure 3. ADuM5402

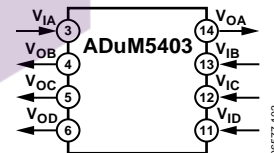

Figure 4. ADuM5403

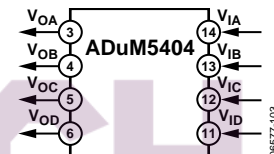

Figure 5. ADuM5404

Table 1. Power Levels

| Input Voltage (V) | Output Voltage (V) | Output Power (mW) |
|-------------------|--------------------|-------------------|
| 5.0 | 5.0 | 500 |
| 5.0 | 3.3 | 330 |
| 3.3 | 3.3 | 200 |

TABLE OF CONTENTS

| | | | |
|--|----|--|----|
| Features | 1 | ESD Caution..... | 12 |
| Applications..... | 1 | Pin Configurations and Function Descriptions | 13 |
| General Description | 1 | Truth Table | 16 |
| Functional Block Diagrams..... | 1 | Typical Performance Characteristics | 17 |
| Revision History | 3 | Terminology | 20 |
| Specifications..... | 4 | Applications Information | 21 |
| Electrical Characteristics—5 V Primary Input Supply/5 V Secondary Isolated Supply | 4 | PCB Layout | 21 |
| Electrical Characteristics—3.3 V Primary Input Supply/3.3 V Secondary Isolated Supply | 6 | Thermal Analysis | 21 |
| Electrical Characteristics—5 V Primary Input Supply/3.3 V Secondary Isolated Supply | 8 | Propagation Delay-Related Parameters..... | 22 |
| Package Characteristics | 10 | Start-Up Behavior..... | 22 |
| Regulatory Information..... | 10 | EMI Considerations | 22 |
| Insulation and Safety-Related Specifications | 10 | DC Correctness and Magnetic Field Immunity..... | 22 |
| IEC 60747-5-2 (VDE 0884, Part 2):2003-01 Insulation Characteristics | 11 | Power Consumption | 23 |
| Recommended Operating Conditions | 11 | Power Considerations..... | 24 |
| Absolute Maximum Ratings..... | 12 | Increasing Available Power | 24 |
| | | Insulation Lifetime | 25 |
| | | Outline Dimensions..... | 26 |
| | | Ordering Guide | 26 |



SKYTECH

تهیه و توزیع قطعات الکترونیک

REVISION HISTORY**3/2019—Rev. C to Rev. D**

| | |
|---------------------------------|----|
| Change to Features Section..... | 1 |
| Change to Table 15..... | 10 |

6/2012—Rev. B to Rev. C

| | |
|--|----|
| Created Hyperlink for Safety and Regulatory Approvals Entry in Features Section | 1 |
| Updated Outline Dimensions..... | 26 |

9/2011—Rev. A to Rev. B

| | |
|--|----|
| Changes to Product Title, Features Section, and General Description Section..... | 1 |
| Added Table 1; Renumbered Sequentially | 1 |
| Changes to Specifications Section..... | 3 |
| Changes to Table 19 and Table 20 | 11 |
| Changes to Table 21 | 12 |
| Changes to Table 22 | 13 |
| Changes to Table 23 | 14 |
| Changes to Table 24 and Table 25 | 15 |
| Changes to Figure 11 to Figure 13 | 16 |
| Changes to Figure 11, Figure 12 Caption, Figure 14 Caption, and Figure 16 Caption | 16 |
| Added Figure 19 and Figure 20; Renumbered Sequentially..... | 17 |
| Changes to Figure 21 and Figure 22 | 17 |
| Changes to Terminology Section | 19 |
| Changes to Applications Information Section | 20 |
| Deleted Increasing Available Power, Figure 15, and Figure 16; Renumbered Sequentially | 20 |
| Changes to PCB Layout Section..... | 20 |
| Added Start-Up Behavior Section..... | 21 |
| Moved and Changes to EMI Considerations Section | 21 |

| | |
|--|----|
| Changes to DC Correctness and Magnetic Field Immunity Section | 21 |
| Changes to Power Consumption Section and Figure 29 | 22 |
| Changes to Power Considerations | 23 |
| Added Increasing Available Power Section and Table 26..... | 23 |
| Added Table 27 | 24 |
| Changes to Insulation Lifetime Section | 24 |

11/2008—Rev. 0 to Rev. A

| | |
|---|----|
| Changes to Figure 1 and General Description Section..... | 1 |
| Changes to Table 1 | 3 |
| Changes to Table 2 | 5 |
| Changes to Table 4 | 7 |
| Changes to Table 6 and Table 7 | 8 |
| Changes to Table 8 and Table 9 | 9 |
| Changes to Figure 7 and Table 10 | 10 |
| Changes to Figure 8 and Table 11 | 11 |
| Changes to Figure 9 and Table 12 | 12 |
| Changes to Figure 10 and Table 13 | 13 |
| Moved Truth Table Section..... | 13 |
| Changes to Applications Information Section and PCB Layout Section | 17 |
| Changes to DC Correctness and Magnetic Field Immunity Section | 18 |
| Changes to Power Considerations Section | 20 |
| Added Increasing Available Power Section, Table 15, and Table 16..... | 20 |

5/2008—Revision 0: Initial Version

SKYTECH

تهیه و توزیع قطعات الکترونیک

SPECIFICATIONS

ELECTRICAL CHARACTERISTICS—5 V PRIMARY INPUT SUPPLY/5 V SECONDARY ISOLATED SUPPLY

Typical specifications are at $T_A = 25^\circ\text{C}$, $V_{DD1} = V_{SEL} = V_{ISO} = 5\text{ V}$. Minimum/maximum specifications apply over the entire recommended operation range which is $4.5\text{ V} \leq V_{DD1}$, V_{SEL} , $V_{ISO} \leq 5.5\text{ V}$; and $-40^\circ\text{C} \leq T_A \leq +105^\circ\text{C}$, unless otherwise noted. Switching specifications are tested with $C_L = 15\text{ pF}$ and CMOS signal levels, unless otherwise noted.

Table 2. DC-to-DC Converter Static Specifications

| Parameter | Symbol | Min | Typ | Max | Unit | Test Conditions/Comments |
|---------------------------------|------------------|-----|-----|-----|--------|---|
| DC-TO-DC CONVERTER SUPPLY | | | | | | |
| Setpoint | V_{ISO} | 4.7 | 5.0 | 5.4 | V | $I_{ISO} = 0\text{ mA}$ |
| Line Regulation | $V_{ISO(LINE)}$ | | 1 | | mV/V | $I_{ISO} = 50\text{ mA}$, $V_{DD1} = 4.5\text{ V to }5.5\text{ V}$ |
| Load Regulation | $V_{ISO(LOAD)}$ | | 1 | 5 | % | $I_{ISO} = 10\text{ mA to }90\text{ mA}$ |
| Output Ripple | $V_{ISO(RIP)}$ | | 75 | | mV p-p | 20 MHz bandwidth, $C_{BO} = 0.1\text{ }\mu\text{F} 10\text{ }\mu\text{F}$, $I_{ISO} = 90\text{ mA}$ |
| Output Noise | $V_{ISO(NOISE)}$ | | 200 | | mV p-p | $C_{BO} = 0.1\text{ }\mu\text{F} 10\text{ }\mu\text{F}$, $I_{ISO} = 90\text{ mA}$ |
| Switching Frequency | f_{OSC} | | 180 | | MHz | |
| PWM Frequency | f_{PWM} | | 625 | | kHz | |
| Output Supply Current | $I_{ISO(MAX)}$ | 100 | | | mA | $V_{ISO} > 4.5\text{ V}$ |
| Efficiency at $I_{ISO(MAX)}$ | | | 34 | | % | $I_{ISO} = 100\text{ mA}$ |
| I_{DD1} , No V_{ISO} Load | $I_{DD1(Q)}$ | | 19 | 30 | mA | |
| I_{DD1} , Full V_{ISO} Load | $I_{DD1(MAX)}$ | | 290 | | mA | |

Table 3. DC-to-DC Converter Dynamic Specifications

| Parameter | Symbol | 1 Mbps—A Grade, C Grade | | | 25 Mbps—C Grade | | | Unit | Test Conditions/Comments |
|-------------------|-----------------|-------------------------|-----|-----|-----------------|-----|-----|-------------------|--------------------------|
| | | Min | Typ | Max | Min | Typ | Max | | |
| SUPPLY CURRENT | | | | | | | | | |
| Input | I_{DD1} | | | | | | | | |
| ADuM5401 | | | 19 | | | 68 | | mA | No V_{ISO} load |
| ADuM5402 | | | 19 | | | 71 | | mA | No V_{ISO} load |
| ADuM5403 | | | 19 | | | 75 | | mA | No V_{ISO} load |
| ADuM5404 | | 19 | | | 78 | | mA | No V_{ISO} load | |
| Available to Load | $I_{ISO(LOAD)}$ | | | | | | | | |
| ADuM5401 | | | 100 | | | 87 | | mA | |
| ADuM5402 | | | 100 | | | 85 | | mA | |
| ADuM5403 | | | 100 | | | 83 | | mA | |
| ADuM5404 | | 100 | | | 81 | | mA | | |

Table 4. Switching Specifications

| Parameter | Symbol | A Grade | | | C Grade | | | Unit | Test Conditions/Comments |
|-----------------------------------|-----------------------|---------|-----|-----|---------|-----|-----|-------|--------------------------|
| | | Min | Typ | Max | Min | Typ | Max | | |
| SWITCHING SPECIFICATIONS | | | | | | | | | |
| Data Rate | | | | 1 | | 25 | | Mbps | Within PWD limit |
| Propagation Delay | t_{PHL} , t_{PLH} | | 55 | 100 | | 45 | 60 | ns | 50% input to 50% output |
| Pulse Width Distortion | PWD | | | 40 | | | 6 | ns | $ t_{PLH} - t_{PHL} $ |
| Change vs. Temperature | | | | | | 5 | | ps/°C | |
| Pulse Width | PW | 1000 | | | 40 | | | ns | Within PWD limit |
| Propagation Delay Skew | t_{PSK} | | | 50 | | | 15 | ns | Between any two units |
| Channel Matching | | | | | | | | | |
| Codirectional ¹ | t_{PSKCD} | | | 50 | | | 6 | ns | |
| Opposing Directional ² | t_{PSKOD} | | | 50 | | | 15 | ns | |

¹ Codirectional channel matching is the absolute value of the difference in propagation delays between any two channels with inputs on the same side of the isolation barrier.

² Opposing directional channel matching is the absolute value of the difference in propagation delays between any two channels with inputs on opposing sides of the isolation barrier.

Table 5. Input and Output Characteristics

| Parameter | Symbol | Min | Typ | Max | Unit | Test Conditions/Comments |
|---|-----------|--|-------|--|-------------|--|
| DC SPECIFICATIONS | | | | | | |
| Logic High Input Threshold | V_{IH} | $0.7 \times V_{ISO}$ or $0.7 \times V_{DD1}$ | | | V | |
| Logic Low Input Threshold | V_{IL} | | | $0.3 \times V_{ISO}$ or $0.3 \times V_{DD1}$ | V | |
| Logic High Output Voltages | V_{OH} | $V_{DD1} - 0.3$ or $V_{ISO} - 0.3$ | 5.0 | | V | $I_{Ox} = -20 \mu A, V_{Ix} = V_{IxH}$ |
| | | $V_{DD1} - 0.5$ or $V_{ISO} - 0.5$ | 4.8 | | V | |
| Logic Low Output Voltages | V_{OL} | | 0.0 | 0.1 | V | $I_{Ox} = 20 \mu A, V_{Ix} = V_{IxL}$ |
| | | | 0.2 | 0.4 | V | |
| Undervoltage Lockout | UVLO | | | | V | $V_{DD1}, V_{DDL}, V_{ISO}$ supplies |
| Positive Going Threshold | V_{UV+} | | 2.7 | | V | |
| Negative Going Threshold | V_{UV-} | | 2.4 | | V | |
| Hysteresis | V_{UVH} | | 0.3 | | V | |
| Input Currents per Channel | I_I | -20 | +0.01 | +20 | μA | $0 V \leq V_{Ix} \leq V_{DDx}$ |
| AC SPECIFICATIONS | | | | | | |
| Output Rise/Fall Time | t_R/t_F | | 2.5 | | ns | 10% to 90% |
| Common-Mode Transient Immunity ¹ | $ CM $ | 25 | 35 | | kV/ μs | $V_{Ix} = V_{DD1}$ or $V_{ISO}, V_{CM} = 1000 V,$ transient magnitude = 800 V |
| Refresh Rate | f_r | | 1.0 | | Mbps | |

¹ $|CM|$ is the maximum common-mode voltage slew rate that can be sustained while maintaining $V_O > 0.7 \times V_{DD1}$ or $0.7 \times V_{ISO}$ for a high output or $V_O < 0.3 \times V_{DD1}$ or $0.3 \times V_{ISO}$ for a low output. The common-mode voltage slew rates apply to both rising and falling common-mode voltage edges.



تهیه و توزیع قطعات الکترونیک

ELECTRICAL CHARACTERISTICS—3.3 V PRIMARY INPUT SUPPLY/3.3 V SECONDARY ISOLATED SUPPLY

Typical specifications are at $T_A = 25^\circ\text{C}$, $V_{DD1} = V_{ISO} = 3.3\text{ V}$, $V_{SEL} = \text{GND}_{ISO}$. Minimum/maximum specifications apply over the entire recommended operation range which is $3.0\text{ V} \leq V_{DD1}$, V_{SEL} , $V_{ISO} \leq 3.6\text{ V}$; and $-40^\circ\text{C} \leq T_A \leq +105^\circ\text{C}$, unless otherwise noted. Switching specifications are tested with $C_L = 15\text{ pF}$ and CMOS signal levels, unless otherwise noted.

Table 6. DC-to-DC Converter Static Specifications

| Parameter | Symbol | Min | Typ | Max | Unit | Test Conditions/Comments |
|-------------------------------------|-------------------------|-----|-----|-----|--------|---|
| DC-TO-DC CONVERTER SUPPLY | | | | | | |
| Setpoint | V_{ISO} | 3.0 | 3.3 | 3.6 | V | $I_{ISO} = 0\text{ mA}$ |
| Line Regulation | $V_{ISO(\text{LINE})}$ | | 1 | | mV/V | $I_{ISO} = 30\text{ mA}$, $V_{DD1} = 3.0\text{ V to }3.6\text{ V}$ |
| Load Regulation | $V_{ISO(\text{LOAD})}$ | | 1 | 5 | % | $I_{ISO} = 6\text{ mA to }54\text{ mA}$ |
| Output Ripple | $V_{ISO(\text{RIP})}$ | | 50 | | mV p-p | 20 MHz bandwidth, $C_{BO} = 0.1\text{ }\mu\text{F} 10\text{ }\mu\text{F}$, $I_{ISO} = 54\text{ mA}$ |
| Output Noise | $V_{ISO(\text{NOISE})}$ | | 130 | | mV p-p | $C_{BO} = 0.1\text{ }\mu\text{F} 10\text{ }\mu\text{F}$, $I_{ISO} = 54\text{ mA}$ |
| Switching Frequency | f_{OSC} | | 180 | | MHz | |
| PWM Frequency | f_{PWM} | | 625 | | kHz | |
| Output Supply Current | $I_{ISO(\text{MAX})}$ | 60 | | | mA | $V_{ISO} > 3\text{ V}$ |
| Efficiency at $I_{ISO(\text{MAX})}$ | | | 33 | | % | $I_{ISO} = 60\text{ mA}$ |
| I_{DD1} , No V_{ISO} Load | $I_{DD1(\text{Q})}$ | | 14 | 20 | mA | |
| I_{DD1} , Full V_{ISO} Load | $I_{DD1(\text{MAX})}$ | | 175 | | mA | |

Table 7. DC-to-DC Converter Dynamic Specifications

| Parameter | Symbol | 1 Mbps—A or C Grade | | | 25 Mbps—C Grade | | | Unit | Test Conditions/Comments |
|-------------------|------------------------|---------------------|-----|-----|-----------------|-----|-----|------|--------------------------|
| | | Min | Typ | Max | Min | Typ | Max | | |
| SUPPLY CURRENT | | | | | | | | | |
| Input | I_{DD1} | | | | | | | | |
| ADuM5401 | | | 14 | | | 44 | | mA | No V_{ISO} load |
| ADuM5402 | | | 14 | | | 46 | | mA | No V_{ISO} load |
| ADuM5403 | | | 14 | | | 47 | | mA | No V_{ISO} load |
| ADuM5404 | | | 14 | | | 51 | | mA | No V_{ISO} load |
| Available to Load | $I_{ISO(\text{LOAD})}$ | | | | | | | | |
| ADuM5401 | | | 60 | | | 52 | | mA | |
| ADuM5402 | | | 60 | | | 51 | | mA | |
| ADuM5403 | | | 60 | | | 49 | | mA | |
| ADuM5404 | | | 60 | | | 48 | | mA | |

Table 8. Switching Specifications

| Parameter | Symbol | A Grade | | | C Grade | | | Unit | Test Conditions/Comments |
|-----------------------------------|-----------------------|---------|-----|-----|---------|-----|-----|-------|--------------------------|
| | | Min | Typ | Max | Min | Typ | Max | | |
| SWITCHING SPECIFICATIONS | | | | | | | | | |
| Data Rate | | | | 1 | | 25 | | Mbps | Within PWD limit |
| Propagation Delay | t_{PHL} , t_{PLH} | | 60 | 100 | | 45 | 60 | ns | 50% input to 50% output |
| Pulse Width Distortion | PWD | | | 40 | | | 6 | ns | $ t_{PLH} - t_{PHL} $ |
| Change vs. Temperature | | | | | | 5 | | ps/°C | |
| Pulse Width | PW | 1000 | | | 40 | | | ns | Within PWD limit |
| Propagation Delay Skew | t_{PSK} | | | 50 | | | 45 | ns | Between any two units |
| Channel Matching | | | | | | | | | |
| Codirectional ¹ | t_{PSKCD} | | | 50 | | | 6 | ns | |
| Opposing Directional ² | t_{PSKOD} | | | 50 | | | 15 | ns | |

¹ Codirectional channel matching is the absolute value of the difference in propagation delays between any two channels with inputs on the same side of the isolation barrier.

² Opposing directional channel matching is the absolute value of the difference in propagation delays between any two channels with inputs on opposing sides of the isolation barrier.

Table 9. Input and Output Characteristics

| Parameter | Symbol | Min | Typ | Max | Unit | Test Conditions/Comments |
|---|-----------|--|-------|-----|-------------|---|
| DC SPECIFICATIONS | | | | | | |
| Logic High Input Threshold | V_{IH} | $0.7 \times V_{ISO}$ or $0.7 \times V_{DD1}$ | | | V | |
| Logic Low Input Threshold | V_{IL} | | | | V | |
| Logic High Output Voltages | V_{OH} | $V_{DD1} - 0.3$ or $V_{ISO} - 0.3$ | 3.3 | | V | $I_{Ox} = -20 \mu A$, $V_{Ix} = V_{IxH}$ |
| Logic Low Output Voltages | V_{OL} | $V_{DD1} - 0.5$ or $V_{ISO} - 0.5$ | 3.1 | | V | $I_{Ox} = -4 \text{ mA}$, $V_{Ix} = V_{IxH}$ |
| Undervoltage Lockout | UVLO | | | | V | $I_{Ox} = 20 \mu A$, $V_{Ix} = V_{IxL}$ |
| Positive Going Threshold | V_{UV+} | | 2.7 | | V | $I_{Ox} = 4 \text{ mA}$, $V_{Ix} = V_{IxL}$ |
| Negative Going Threshold | V_{UV-} | | 2.4 | | V | V_{DD1} , V_{DDL} , V_{ISO} supplies |
| Hysteresis | V_{UVH} | | 0.3 | | V | |
| Input Currents per Channel | I_I | -10 | +0.01 | +10 | μA | $0 \text{ V} \leq V_{Ix} \leq V_{DDx}$ |
| AC SPECIFICATIONS | | | | | | |
| Output Rise/Fall Time | t_R/t_F | | 2.5 | | ns | 10% to 90% |
| Common-Mode Transient Immunity ¹ | $ CM $ | 25 | 35 | | kV/ μs | $V_{Ix} = V_{DD1}$ or V_{ISO} , $V_{CM} = 1000 \text{ V}$, transient magnitude = 800 V |
| Refresh Rate | f_r | | 1.0 | | Mbps | |

¹ $|CM|$ is the maximum common-mode voltage slew rate that can be sustained while maintaining $V_O > 0.7 \times V_{DD1}$ or $0.7 \times V_{ISO}$ for a high output or $V_O < 0.3 \times V_{DD1}$ or $0.3 \times V_{ISO}$ for a low output. The common-mode voltage slew rates apply to both rising and falling common-mode voltage edges.



SKYTECH

تهیه و توزیع قطعات الکترونیک

ELECTRICAL CHARACTERISTICS—5 V PRIMARY INPUT SUPPLY/3.3 V SECONDARY ISOLATED SUPPLY

Typical specifications are at $T_A = 25^\circ\text{C}$, $V_{DD1} = 5.0\text{ V}$, $V_{ISO} = 3.3\text{ V}$, $V_{SEL} = \text{GND}_{ISO}$. Minimum/maximum specifications apply over the entire recommended operation range which is $4.5\text{ V} \leq V_{DD1} \leq 5.5\text{ V}$, $3.0\text{ V} \leq V_{ISO} \leq 3.6\text{ V}$; and $-40^\circ\text{C} \leq T_A \leq +105^\circ\text{C}$, unless otherwise noted. Switching specifications are tested with $C_L = 15\text{ pF}$ and CMOS signal levels, unless otherwise noted.

Table 10. DC-to-DC Converter Static Specifications

| Parameter | Symbol | Min | Typ | Max | Unit | Test Conditions/Comments |
|-------------------------------------|-------------------------|-----|-----|-----|--------|---|
| DC-TO-DC CONVERTER SUPPLY | | | | | | |
| Setpoint | V_{ISO} | 3.0 | 3.3 | 3.6 | V | $I_{ISO} = 0\text{ mA}$ |
| Line Regulation | $V_{ISO}(\text{LINE})$ | | 1 | | mV/V | $I_{ISO} = 50\text{ mA}$, $V_{DD1} = 3.0\text{ V to } 3.6\text{ V}$ |
| Load Regulation | $V_{ISO}(\text{LOAD})$ | | 1 | 5 | % | $I_{ISO} = 6\text{ mA to } 54\text{ mA}$ |
| Output Ripple | $V_{ISO}(\text{RIP})$ | | 50 | | mV p-p | 20 MHz bandwidth, $C_{BO} = 0.1\ \mu\text{F} 10\ \mu\text{F}$, $I_{ISO} = 90\text{ mA}$ |
| Output Noise | $V_{ISO}(\text{NOISE})$ | | 130 | | mV p-p | $C_{BO} = 0.1\ \mu\text{F} 10\ \mu\text{F}$, $I_{ISO} = 90\text{ mA}$ |
| Switching Frequency | f_{OSC} | | 180 | | MHz | |
| PWM Frequency | f_{PWM} | | 625 | | kHz | |
| Output Supply Current | $I_{ISO}(\text{MAX})$ | 100 | | | mA | $V_{ISO} > 3\text{ V}$ |
| Efficiency at $I_{ISO}(\text{MAX})$ | | | 30 | | % | $I_{ISO} = 90\text{ mA}$ |
| I_{DD1} , No V_{ISO} Load | $I_{DD1}(\text{Q})$ | | 14 | 20 | mA | |
| I_{DD1} , Full V_{ISO} Load | $I_{DD1}(\text{MAX})$ | | 230 | | mA | |

Table 11. DC-to-DC Converter Dynamic Specifications

| Parameter | Symbol | 1 Mbps—A or C Grade | | | 25 Mbps—C Grade | | | Unit | Test Conditions/Comments |
|-----------------------|------------------------|---------------------|-----|-----|-----------------|-----|-----|------|--------------------------|
| | | Min | Typ | Max | Min | Typ | Max | | |
| SUPPLY CURRENT | | | | | | | | | |
| Input | I_{DD1} | | | | | | | | |
| ADuM5401 | | | 9 | | | 44 | | mA | No V_{ISO} load |
| ADuM5402 | | | 9 | | | 45 | | mA | No V_{ISO} load |
| ADuM5403 | | | 9 | | | 46 | | mA | No V_{ISO} load |
| ADuM5404 | | | 9 | | | 47 | | mA | No V_{ISO} load |
| Available to Load | $I_{ISO}(\text{LOAD})$ | | | | | | | | |
| ADuM5401 | | | 100 | | | 92 | | mA | |
| ADuM5402 | | | 100 | | | 91 | | mA | |
| ADuM5403 | | | 100 | | | 89 | | mA | |
| ADuM5404 | | | 100 | | | 88 | | mA | |

Table 12. Switching Specifications

| Parameter | Symbol | A Grade | | | C Grade | | | Unit | Test Conditions/Comments |
|-----------------------------------|-----------------------|---------|-----|-----|---------|-----|-----|----------------------|--------------------------|
| | | Min | Typ | Max | Min | Typ | Max | | |
| SWITCHING SPECIFICATIONS | | | | | | | | | |
| Data Rate | | | | 1 | | 25 | | Mbps | Within PWD limit |
| Propagation Delay | t_{PHL} , t_{PLH} | | 60 | 100 | | 45 | 60 | ns | 50% input to 50% output |
| Pulse Width Distortion | PWD | | | 40 | | | 6 | ns | $ t_{PLH} - t_{PHL} $ |
| Change vs. Temperature | | | | | | 5 | | ps/ $^\circ\text{C}$ | |
| Pulse Width | PW | 1000 | | | 40 | | | ns | Within PWD limit |
| Propagation Delay Skew | t_{PSK} | | | 50 | | | 15 | ns | Between any two units |
| Channel Matching | | | | | | | | | |
| Codirectional ¹ | t_{PSKCD} | | | 50 | | | 6 | ns | |
| Opposing Directional ² | t_{PSKOD} | | | 50 | | | 15 | ns | |

¹ Codirectional channel matching is the absolute value of the difference in propagation delays between any two channels with inputs on the same side of the isolation barrier.

² Opposing directional channel matching is the absolute value of the difference in propagation delays between any two channels with inputs on opposing sides of the isolation barrier.

Table 13. Input and Output Characteristics

| Parameter | Symbol | Min | Typ | Max | Unit | Test Conditions/Comments |
|---|-----------|--|---------------------------------------|--|-------------|---|
| DC SPECIFICATIONS | | | | | | |
| Logic High Input Threshold | V_{IH} | $0.7 \times V_{ISO}$ or $0.7 \times V_{DD1}$ | | | V | |
| Logic Low Input Threshold | V_{IL} | | | $0.3 \times V_{ISO}$ or $0.3 \times V_{DD1}$ | V | |
| Logic High Output Voltages | V_{OH} | $V_{DD1} - 0.2$, $V_{ISO} - 0.2$ $V_{DD1} - 0.5$ or $V_{ISO} - 0.5$ | V_{DD1} or V_{ISO} | | V | $I_{Ox} = -20 \mu A$, $V_{Ix} = V_{IxH}$ |
| | | | $V_{DD1} - 0.2$ or $V_{ISO} - 0.2$ | | V | $I_{Ox} = -4 mA$, $V_{Ix} = V_{IxH}$ |
| Logic Low Output Voltages | V_{OL} | | 0.0 | 0.1 | V | $I_{Ox} = 20 \mu A$, $V_{Ix} = V_{IxL}$ |
| | | | 0.0 | 0.4 | V | $I_{Ox} = 4 mA$, $V_{Ix} = V_{IxL}$ |
| Undervoltage Lockout | UVLO | | | | | V_{DD1} , V_{DDL} , V_{ISO} supplies |
| Positive Going Threshold | V_{UV+} | | 2.7 | | V | |
| Negative Going Threshold | V_{UV-} | | 2.4 | | V | |
| Hysteresis | V_{UVH} | | 0.3 | | V | |
| Input Currents per Channel | I_I | -10 | +0.01 | +10 | μA | $0 V \leq V_{Ix} \leq V_{DDx}$ |
| AC SPECIFICATIONS | | | | | | |
| Output Rise/Fall Time | t_R/t_F | | 2.5 | | ns | 10% to 90% |
| Common-Mode Transient Immunity ¹ | $ CM $ | 25 | 35 | | kV/ μs | $V_{Ix} = V_{DD1}$ or V_{ISO} , $V_{CM} = 1000 V$, transient magnitude = 800 V |
| Refresh Rate | f_r | | 1.0 | | Mbps | |

¹ $|CM|$ is the maximum common-mode voltage slew rate that can be sustained while maintaining $V_O > 0.7 \times V_{DD1}$ or $0.7 \times V_{ISO}$ for a high output or $V_O < 0.3 \times V_{DD1}$ or $0.3 \times V_{ISO}$ for a low output. The common-mode voltage slew rates apply to both rising and falling common-mode voltage edges.

SKYTECH

تهیه و توزیع قطعات الکترونیک

PACKAGE CHARACTERISTICS

Table 14.

| Parameter | Symbol | Min | Typ | Max | Unit | Test Conditions/Comments |
|--|------------------|-----|------------------|-----|------|--|
| RESISTANCE AND CAPACITANCE | | | | | | |
| Resistance (Input-to-Output) ¹ | R _{I-O} | | 10 ¹² | | Ω | f = 1 MHz |
| Capacitance (Input-to-Output) ¹ | C _{I-O} | | 2.2 | | pF | |
| Input Capacitance ² | C _I | | 4.0 | | pF | |
| IC Junction-to-Ambient Thermal Resistance | θ _{JA} | | 45 | | °C/W | Thermocouple located at center of package underside, test conducted on 4-layer board with thin traces ³ |

¹ This device is considered a 2-terminal device; Pin 1 through Pin 8 are shorted together, and Pin 9 through Pin 16 are shorted together.

² Input capacitance is from any input data pin to ground.

³ See the Thermal Analysis section for thermal model definitions.

REGULATORY INFORMATION

The ADuM5401/ADuM5402/ADuM5403/ADuM5404 are approved by the organizations listed in Table 15. Refer to Table 20 and the Insulation Lifetime section for more information about the recommended maximum working voltages for specific cross-insulation waveforms and insulation levels.

Table 15.

| UL ¹ | CSA | VDE ² |
|---|---|---|
| Recognized Under 1577 Component Recognition Program ¹ Single Protection, 2500 V rms Isolation Voltage File E214100 | Approved under CSA Component Acceptance Notice 5A Testing was conducted per CSA 60950-1-07 and IEC 60950-1 2 nd Ed. at 2.5 kV rated voltage Basic insulation at 600 V rms (848 V peak) working voltage Reinforced insulation at 250 V rms (353 V peak) working voltage File 205078 | Certified according to IEC 60747-5-2 (VDE 0884 Part 2):2003-01 ² Basic insulation, 560 V peak File 2471900-4880-0001 |

¹ In accordance with UL 1577, each ADuM5401/ADuM5402/ADuM5403/ADuM5404 is proof tested by applying an insulation test voltage ≥ 3000 V rms for 1 second (current leakage detection limit = 10 μA).

² In accordance with IEC 60747-5-2 (VDE 0884 Part 2):2003-01, each ADuM5401/ADuM5402/ADuM5403/ADuM5404 is proof tested by applying an insulation test voltage ≥ 1590 V peak for 1 second (partial discharge detection limit = 5 pC). The asterisk (*) marking branded on the component designates IEC 60747-5-2 (VDE 0884 Part 2):2003-01 approval.

INSULATION AND SAFETY-RELATED SPECIFICATIONS

Table 16. Critical Safety-Related Dimensions and Material Properties

| Parameter | Symbol | Value | Unit | Test Conditions/Comments |
|--|--------|-----------|-------|--|
| Rated Dielectric Insulation Voltage | | 2500 | V rms | 1-minute duration |
| Minimum External Air Distance | L(I01) | 8.0 | mm | Measured from input terminals to output terminals, shortest distance through air |
| Minimum External Tracking (Creepage) | L(I02) | 7.6 | mm | Measured from input terminals to output terminals, shortest distance path along body |
| Minimum Internal Gap (Internal Clearance) | | 0.017 min | mm | Distance through insulation |
| Tracking Resistance (Comparative Tracking Index) | CTI | >175 | V | DIN IEC 112/VDE 0303, Part 1 |
| Material Group | | IIIa | | Material Group (DIN VDE 0110, 1/89, Table 1) |

IEC 60747-5-2 (VDE 0884, PART 2):2003-01 INSULATION CHARACTERISTICS

These isolators are suitable for reinforced electrical isolation only within the safety limit data. Maintenance of the safety data is ensured by the protective circuits. The asterisk (*) marking branded on the package denotes IEC 60747-5-2 (VDE 0884, Part 2) approval.

Table 17. VDE Characteristics

| Description | Conditions | Symbol | Characteristic | Unit |
|---|--|------------|--------------------------------|--------|
| Installation Classification per DIN VDE 0110 For Rated Mains Voltage ≤ 150 V rms For Rated Mains Voltage ≤ 300 V rms For Rated Mains Voltage ≤ 400 V rms | | | I to IV I to III I to II | |
| Climatic Classification | | | 40/105/21 | |
| Pollution Degree per DIN VDE 0110, Table 1 | | | 2 | |
| Maximum Working Insulation Voltage | | V_{IORM} | 560 | V peak |
| Input-to-Output Test Voltage, Method b1 | $V_{IORM} \times 1.875 = V_{PR}$, 100% production test, $t_m = 1$ sec, partial discharge < 5 pC | V_{PR} | 1050 | V peak |
| Input-to-Output Test Voltage, Method a | | V_{PR} | | |
| After Environmental Tests Subgroup 1 | $V_{IORM} \times 1.6 = V_{PR}$, $t_m = 60$ sec, partial discharge < 5 pC | | 896 | V peak |
| After Input and/or Safety Test Subgroup 2 and Subgroup 3 | $V_{IORM} \times 1.2 = V_{PR}$, $t_m = 60$ sec, partial discharge < 5 pC | | 672 | V peak |
| Highest Allowable Overvoltage | Transient overvoltage, $t_{TR} = 10$ sec | V_{TR} | 4000 | V peak |
| Safety Limiting Values | Maximum value allowed in the event of a failure (see Figure 6) | | | |
| Case Temperature | | T_S | 150 | °C |
| Side 1 I_{DD1} Current | | I_{S1} | 555 | mA |
| Insulation Resistance at T_S | $V_{IO} = 500$ V | R_S | >10 ⁹ | Ω |

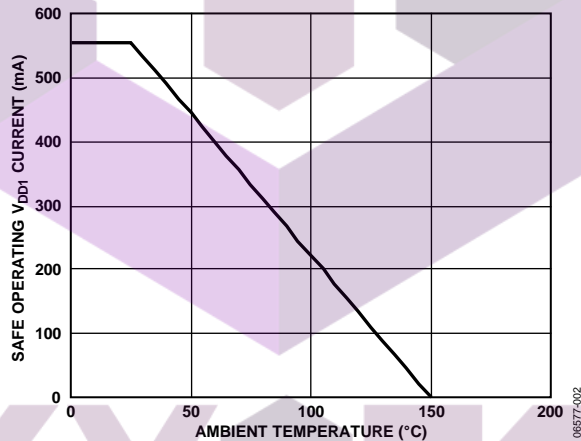

Figure 6. Thermal Derating Curve, Dependence of Safety Limiting Values on Case Temperature, per DIN EN 60747-5-2

RECOMMENDED OPERATING CONDITIONS

Table 18.

| Parameter | Symbol | Min | Max | Unit |
|------------------------------------|----------|-----|------|------|
| Operating Temperature ¹ | T_A | -40 | +105 | °C |
| Supply Voltages ² | | | | |
| $V_{DD1} @ V_{SEL} = 0$ V | V_{DD} | 3.0 | 5.5 | V |
| $V_{DD1} @ V_{SEL} = V_{ISO}$ | V_{DD} | 4.5 | 5.5 | V |

¹ Operation at 105°C requires reduction of the maximum load current as specified in Table 19.

² Each voltage is relative to its respective ground.

ABSOLUTE MAXIMUM RATINGS

Ambient temperature = 25°C, unless otherwise noted.

Table 19.

| Parameter | Rating |
|--|--------------------------------------|
| Storage Temperature Range (T_{ST}) | -55°C to +150°C |
| Ambient Operating Temperature Range (T_A) | -40°C to +105°C |
| Supply Voltages (V_{DD1} , V_{ISO}) ¹ | -0.5 V to +7.0 V |
| Input Voltage (V_{IA} , V_{IB} , V_{IC} , V_{ID} , V_{SEL}) ^{1,2} | -0.5 V to $V_{DD1} + 0.5$ V |
| Output Voltage (V_{OA} , V_{OB} , V_{OC} , V_{OD}) ^{1,2} | -0.5 V to $V_{DD0} + 0.5$ V |
| Average Output Current per Pin ³ | -10 mA to +10 mA |
| Common-Mode Transients ⁴ | -100 kV/ μ s to +100 kV/ μ s |

¹ Each voltage is relative to its respective ground.

² V_{DD1} and V_{DD0} refer to the supply voltages on the input and output sides of a given channel, respectively. See the PCB Layout section.

³ See Figure 6 for maximum rated current values for various temperatures.

⁴ Common-mode transients exceeding the absolute maximum slew rate may cause latch-up or permanent damage.

Stresses at or above those listed under Absolute Maximum Ratings may cause permanent damage to the product. This is a stress rating only; functional operation of the product at these or any other conditions above those indicated in the operational section of this specification is not implied. Operation beyond the maximum operating conditions for extended periods may affect product reliability.

ESD CAUTION



ESD (electrostatic discharge) sensitive device. Charged devices and circuit boards can discharge without detection. Although this product features patented or proprietary protection circuitry, damage may occur on devices subjected to high energy ESD. Therefore, proper ESD precautions should be taken to avoid performance degradation or loss of functionality.

Table 20. Maximum Continuous Working Voltage Supporting 50-Year Minimum Lifetime¹

| Parameter | Max | Unit | Applicable Certification |
|-------------------------------|-----|--------|---------------------------------------|
| AC Voltage, Bipolar Waveform | 424 | V peak | All certifications, 50-year operation |
| AC Voltage, Unipolar Waveform | | | |
| Basic Insulation | 600 | V peak | Working voltage per IEC 60950-1 |
| Reinforced Insulation | 353 | V peak | Working voltage per IEC 60950-1 |
| DC Voltage | | | |
| Basic Insulation | 600 | V peak | Working voltage per IEC 60950-1 |
| Reinforced Insulation | 353 | V peak | Working voltage per IEC 60950-1 |

¹ Refers to the continuous voltage magnitude imposed across the isolation barrier. See the Insulation Lifetime section for more information.

SKYTECH

تهیه و توزیع قطعات الکترونیک

PIN CONFIGURATIONS AND FUNCTION DESCRIPTIONS

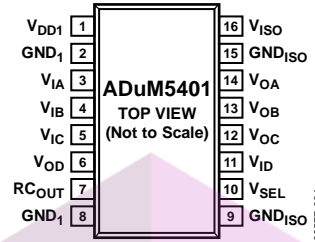

Figure 7. ADuM5401 Pin Configuration

Table 21. ADuM5401 Pin Function Descriptions

| Pin No. | Mnemonic | Description |
|---------|--------------------|---|
| 1 | V _{DD1} | Primary Supply Voltage, 3.0 V to 5.5 V. |
| 2, 8 | GND ₁ | Ground 1. Ground reference for isolator primary. Pin 2 and Pin 8 are internally connected, and it is recommended that both pins be connected to a common ground. |
| 3 | V _{IA} | Logic Input A. |
| 4 | V _{IB} | Logic Input B. |
| 5 | V _{IC} | Logic Input C. |
| 6 | V _{OD} | Logic Output D. |
| 7 | RC _{OUT} | Regulation Control Output. This pin is connected to the RC _{IN} pin of a slave <i>iso</i> Power device to allow the ADuM5401 to control the regulation of the slave device. |
| 9, 15 | GND _{ISO} | Ground Reference for Isolator Side 2. Pin 9 and Pin 15 are internally connected, and it is recommended that both pins be connected to a common ground. |
| 10 | V _{SEL} | Output Voltage Selection. When V _{SEL} = V _{ISO} , the V _{ISO} setpoint is 5.0 V. When V _{SEL} = GND _{ISO} , the V _{ISO} setpoint is 3.3 V. |
| 11 | V _{ID} | Logic Input D. |
| 12 | V _{OC} | Logic Output C. |
| 13 | V _{OB} | Logic Output B. |
| 14 | V _{OA} | Logic Output A. |
| 16 | V _{ISO} | Secondary Supply Voltage Output for External Loads, 3.3 V (V _{SEL} Low) or 5.0 V (V _{SEL} High). |

SKYTECH

تهیه و توزیع قطعات الکترونیک

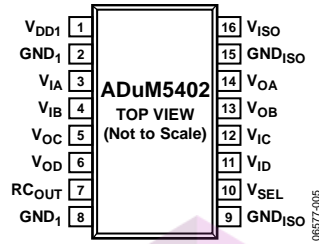

Figure 8. ADuM5402 Pin Configuration

Table 22. ADuM5402 Pin Function Descriptions

| Pin No. | Mnemonic | Description |
|---------|--------------------|---|
| 1 | V _{DD1} | Primary Supply Voltage, 3.0 V to 5.5 V. |
| 2, 8 | GND ₁ | Ground 1. Ground reference for isolator primary. Pin 2 and Pin 8 are internally connected, and it is recommended that both pins be connected to a common ground. |
| 3 | V _{IA} | Logic Input A. |
| 4 | V _{IB} | Logic Input B. |
| 5 | V _{OC} | Logic Output C. |
| 6 | V _{OD} | Logic Output D. |
| 7 | RC _{OUT} | Regulation Control Output. This pin is connected to the RC _{IN} pin of a slave <i>iso</i> Power device to allow the ADuM5402 to control the regulation of the slave device. |
| 9, 15 | GND _{ISO} | Ground Reference for Isolator Side 2. Pin 9 and Pin 15 are internally connected, and it is recommended that both pins be connected to a common ground. |
| 10 | V _{SEL} | Output Voltage Selection. When V _{SEL} = V _{ISO} , the V _{ISO} setpoint is 5.0 V. When V _{SEL} = GND _{ISO} , the V _{ISO} setpoint is 3.3 V. |
| 11 | V _{ID} | Logic Input D. |
| 12 | V _{IC} | Logic Input C. |
| 13 | V _{OB} | Logic Output B. |
| 14 | V _{OA} | Logic Output A. |
| 16 | V _{ISO} | Secondary Supply Voltage Output for External Loads, 3.3 V (V _{SEL} Low) or 5.0 V (V _{SEL} High). |

SKYTECH

تهیه و توزیع قطعات الکترونیک

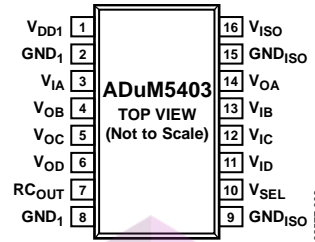

Figure 9. ADuM5403 Pin Configuration

Table 23. ADuM5403 Pin Function Descriptions

| Pin No. | Mnemonic | Description |
|---------|--------------------|---|
| 1 | V _{DD1} | Primary Supply Voltage, 3.0 V to 5.5 V. |
| 2, 8 | GND ₁ | Ground 1. Ground reference for isolator primary. Pin 2 and Pin 8 are internally connected, and it is recommended that both pins be connected to a common ground. |
| 3 | V _{IA} | Logic Input A. |
| 4 | V _{OB} | Logic Output B. |
| 5 | V _{OC} | Logic Output C. |
| 6 | V _{OD} | Logic Output D. |
| 7 | R _{COUT} | Regulation Control Output. This pin is connected to the R _{CIN} pin of a slave <i>iso</i> Power device to allow the ADuM5403 to control the regulation of the slave device. |
| 9, 15 | GND _{ISO} | Ground Reference for Isolator Side 2. Pin 9 and Pin 15 are internally connected, and it is recommended that both pins be connected to a common ground. |
| 10 | V _{SEL} | Output Voltage Selection. When V _{SEL} = V _{ISO} , the V _{ISO} setpoint is 5.0 V. When V _{SEL} = GND _{ISO} , the V _{ISO} setpoint is 3.3 V. |
| 11 | V _{ID} | Logic Input D. |
| 12 | V _{IC} | Logic Input C. |
| 13 | V _{IB} | Logic Input B. |
| 14 | V _{OA} | Logic Output A. |
| 16 | V _{ISO} | Secondary Supply Voltage Output for External Loads, 3.3 V (V _{SEL} Low) or 5.0 V (V _{SEL} High). |

SKYTECH

تهیه و توزیع قطعات الکترونیک

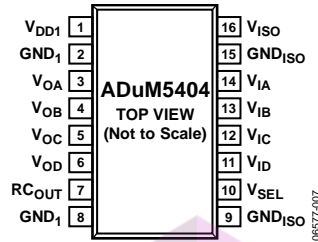

Figure 10. ADuM5404 Pin Configuration

Table 24. ADuM5404 Pin Function Descriptions

| Pin No. | Mnemonic | Description |
|---------|--------------------|---|
| 1 | V _{DD1} | Primary Supply Voltage, 3.0 V to 5.5 V. |
| 2, 8 | GND ₁ | Ground 1. Ground reference for isolator primary. Pin 2 and Pin 8 are internally connected, and it is recommended that both pins be connected to a common ground. |
| 3 | V _{OA} | Logic Output A. |
| 4 | V _{OB} | Logic Output B. |
| 5 | V _{OC} | Logic Output C. |
| 6 | V _{OD} | Logic Output D. |
| 7 | RC _{OUT} | Regulation Control Output. This pin is connected to the RC _{IN} pin of a slave <i>isoPower</i> device to allow the ADuM5404 to control the regulation of the slave device. |
| 9, 15 | GND _{ISO} | Ground Reference for Isolator Side 2. Pin 9 and Pin 15 are internally connected, and it is recommended that both pins be connected to a common ground. |
| 10 | V _{SEL} | Output Voltage Selection. When V _{SEL} = V _{ISO} , the V _{ISO} setpoint is 5.0 V. When V _{SEL} = GND _{ISO} , the V _{ISO} setpoint is 3.3 V. |
| 11 | V _{ID} | Logic Input D. |
| 12 | V _{IC} | Logic Input C. |
| 13 | V _{IB} | Logic Input B. |
| 14 | V _{IA} | Logic Input A. |
| 16 | V _{ISO} | Secondary Supply Voltage Output for External Loads, 3.3 V (V _{SEL} Low) or 5.0 V (V _{SEL} High). |

TRUTH TABLE

Table 25. Truth Table (Positive Logic)

| V _{SEL} ¹ | RC _{OUT} ² | V _{DD1} (V) | V _{ISO} (V) | Notes |
|-------------------------------|--------------------------------|----------------------|----------------------|---|
| H | PWM | 5 | 5 | Master mode, normal operation |
| L | PWM | 5 | 3.3 | Master mode, normal operation |
| L | PWM | 3.3 | 3.3 | Master mode, normal operation |
| H | PWM | 3.3 | 5 | This supply configuration is not recommended due to extremely poor efficiency |

¹ H refers to a high logic, and L refers to a low logic.² PWM refers to the regulation control signal. This signal is derived from the secondary side regulator and can be used to control other *isoPower* devices.

SKYTECH

تهیه و توزیع قطعات الکترونیک

TYPICAL PERFORMANCE CHARACTERISTICS

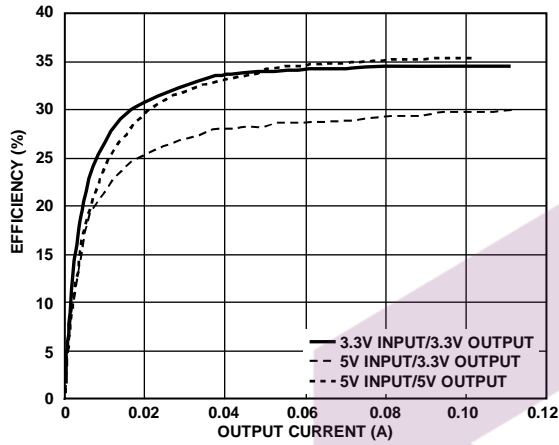

Figure 11. Typical Power Supply Efficiency at 5 V Input/5 V Output and 3.3 V Input/3.3 V Output

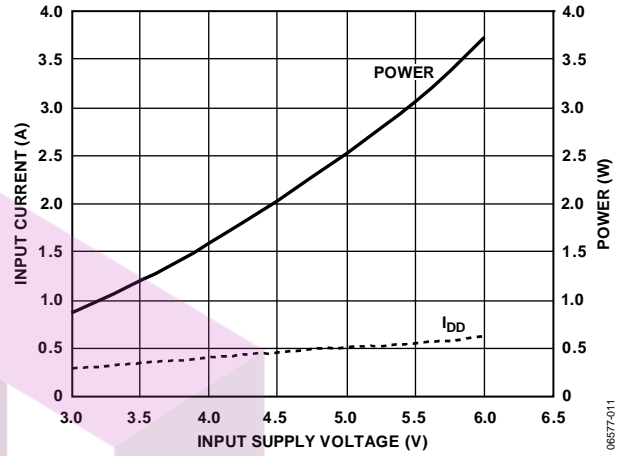

Figure 14. Typical Short-Circuit Input Current and Power vs. V_{DD1} Supply Voltage

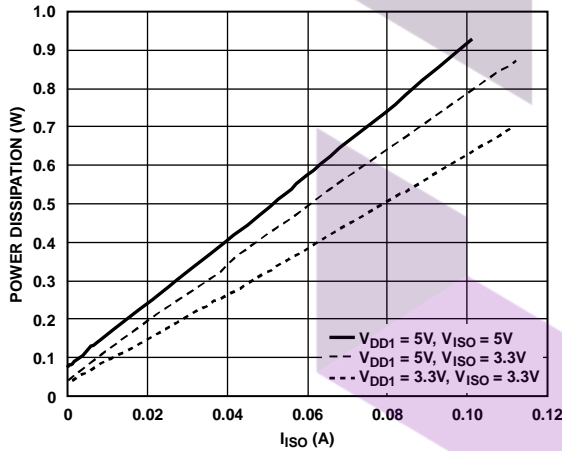

Figure 12. Typical Total Power Dissipation vs. Isolated Output Supply Current in All Supported Power Configurations

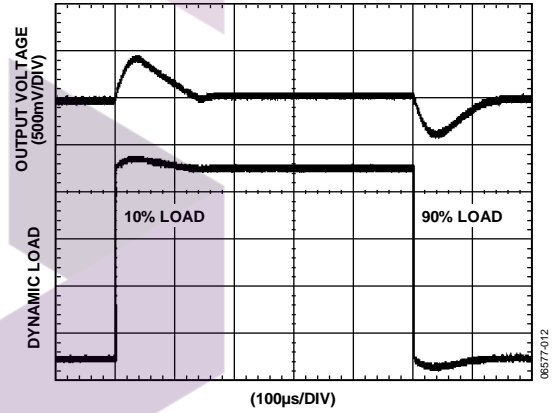

Figure 15. Typical V_{ISO} Transient Load Response, 5 V Output, 10% to 90% Load Step

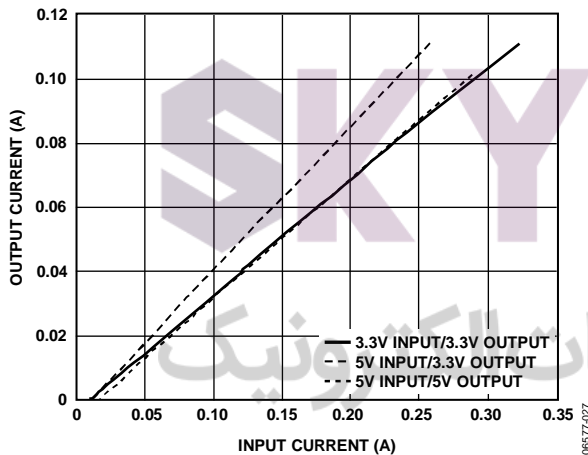

Figure 13. Typical Isolated Output Supply Current vs. Input Current in All Supported Power Configurations

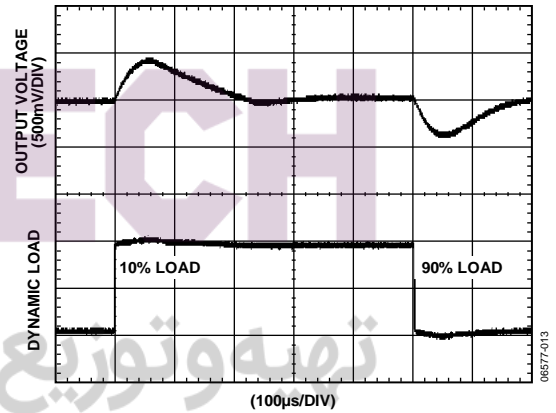

Figure 16. Typical V_{ISO} Transient Load Response, 3.3 V Output, 10% to 90% Load Step

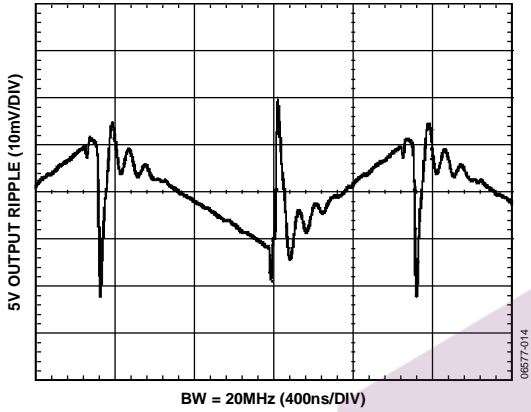

Figure 17. Typical $V_{ISO} = 5\text{ V}$ Output Voltage Ripple at 90% Load

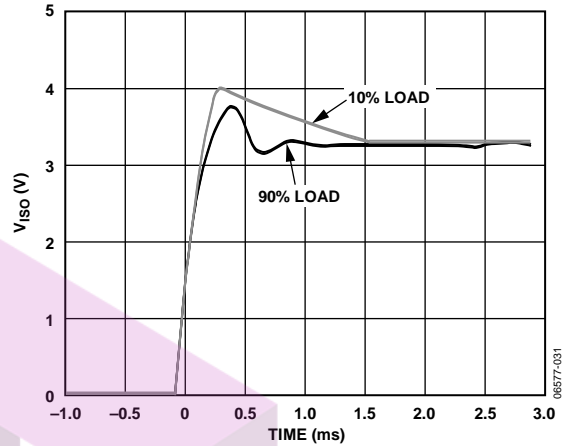

Figure 20. Typical Output Voltage Start-Up Transient at 10% and 90% Load, $V_{ISO} = 3.3\text{ V}$

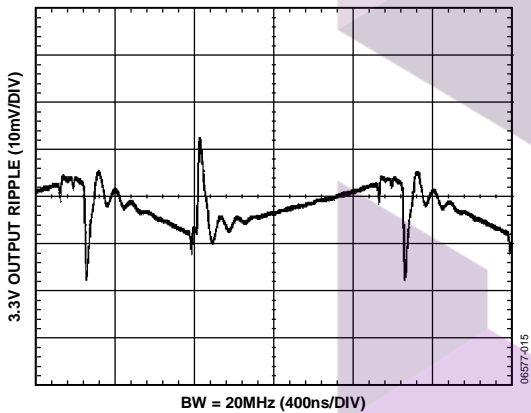

Figure 18. Typical $V_{ISO} = 3.3\text{ V}$ Output Voltage Ripple at 90% Load

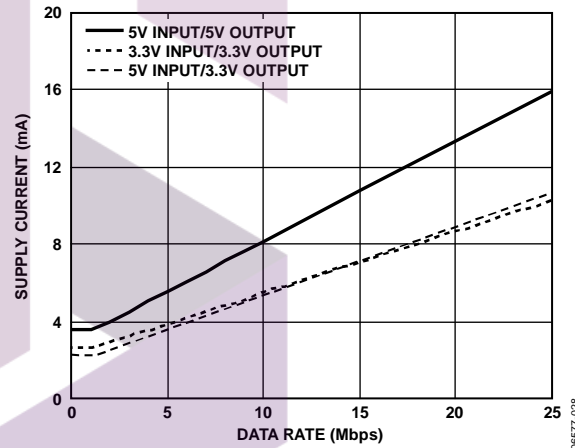

Figure 21. Typical I_{CH} Supply Current per Forward Data Channel (15 pF Output Load)

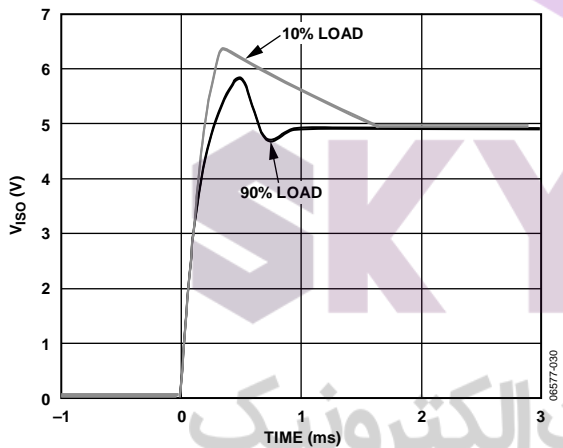

Figure 19. Typical Output Voltage Start-Up Transient at 10% and 90% Load, $V_{ISO} = 5\text{ V}$

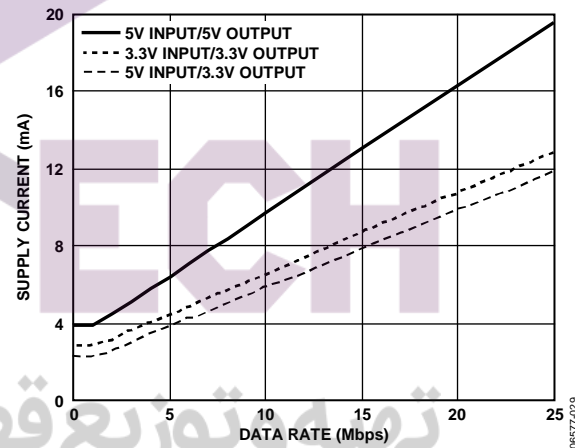

Figure 22. Typical I_{CH} Supply Current per Reverse Data Channel (15 pF Output Load)

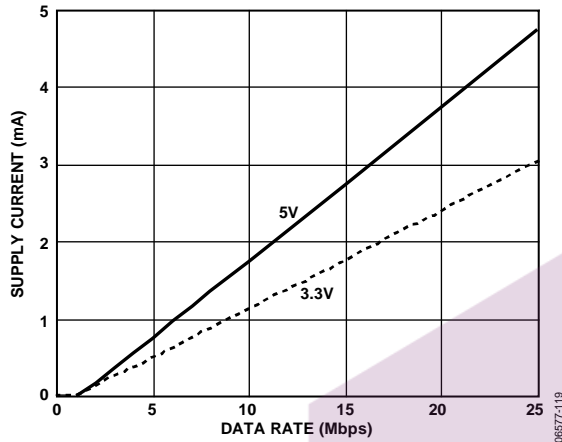

Figure 23. Typical $I_{ISO(D)}$ Dynamic Supply Current per Input

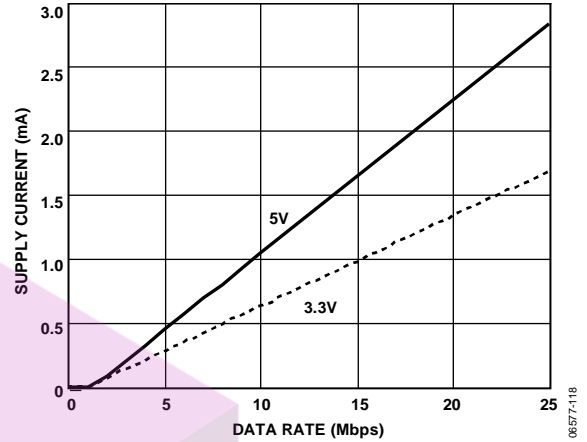

Figure 24. Typical $I_{ISO(D)}$ Dynamic Supply Current per Output (15 pF Output Load)

SKYTECH

تهیه و توزیع قطعات الکترونیک

TERMINOLOGY

$I_{DD1(Q)}$

$I_{DD1(Q)}$ is the minimum operating current drawn at the V_{DD1} pin when there is no external load at V_{ISO} and the I/O pins are operating below 2 Mbps, requiring no additional dynamic supply current. $I_{DD1(Q)}$ reflects the minimum current operating condition.

$I_{DD1(D)}$

$I_{DD1(D)}$ is the typical input supply current with all channels simultaneously driven at a maximum data rate of 25 Mbps with full capacitive load representing the maximum dynamic load conditions. Resistive loads on the outputs should be treated separately from the dynamic load.

$I_{DD1(MAX)}$

$I_{DD1(MAX)}$ is the input current under full dynamic and V_{ISO} load conditions.

$I_{SO(LOAD)}$

$I_{SO(LOAD)}$ is the current available to the load.

t_{PHL} Propagation Delay

The t_{PHL} propagation delay is measured from the 50% level of the falling edge of the V_{Ix} signal to the 50% level of the falling edge of the V_{Ox} signal.

t_{PLH} Propagation Delay

t_{PLH} propagation delay is measured from the 50% level of the rising edge of the V_{Ix} signal to the 50% level of the rising edge of the V_{Ox} signal.

Propagation Delay Skew, t_{PSK}

t_{PSK} is the magnitude of the worst-case difference in t_{PHL} and/or t_{PLH} that is measured between units at the same operating temperature, supply voltages, and output load within the recommended operating conditions.

Channel-to-Channel Matching, (t_{PSKCD}/t_{PSKOD})

Channel-to-channel matching is the absolute value of the difference in propagation delays between two channels when operated with identical loads.

Minimum Pulse Width

The minimum pulse width is the shortest pulse width at which the specified pulse width distortion is guaranteed.

Maximum Data Rate

The maximum data rate is the fastest data rate at which the specified pulse width distortion is guaranteed.

SKYTECH

تهیه و توزیع قطعات الکترونیک

APPLICATIONS INFORMATION

The dc-to-dc converter section of the [ADuM5401/ADuM5402/ADuM5403/ADuM5404](#) works on principles that are common to most switching power supplies. It has a secondary side controller architecture with isolated pulse-width modulation (PWM) feedback. V_{DD1} power is supplied to an oscillating circuit that switches current into a chip scale air core transformer. Power transferred to the secondary side is rectified and regulated to either 3.3 V or 5 V. The secondary (V_{ISO}) side controller regulates the output by creating a PWM control signal that is sent to the primary (V_{DD1}) side by a dedicated *iCoupler* data channel. The PWM modulates the oscillator circuit to control the power being sent to the secondary side. Feedback allows for significantly higher power and efficiency.

The [ADuM5401/ADuM5402/ADuM5403/ADuM5404](#) implement undervoltage lockout (UVLO) with hysteresis on the V_{DD1} power input. This feature ensures that the converter does not enter oscillation due to noisy input power or slow power-on ramp rates.

PCB LAYOUT

The [ADuM5401/ADuM5402/ADuM5403/ADuM5404](#) digital isolators with 0.5 W *isoPower* integrated dc-to-dc converter require no external interface circuitry for the logic interfaces. Power supply bypassing is required at the input and output supply pins (see Figure 25). Note that low ESR bypass capacitors are required between Pin 1 and Pin 2 and between Pin 15 and Pin 16, as close to the chip pads as possible.

The power supply section of the [ADuM5401/ADuM5402/ADuM5403/ADuM5404](#) uses a 180 MHz oscillator frequency to pass power efficiently through its chip scale transformers. In addition, the normal operation of the data section of the *iCoupler* introduces switching transients on the power supply pins. Bypass capacitors are required for several operating frequencies. Noise suppression requires a low inductance, high frequency capacitor; ripple suppression and proper regulation require a large value capacitor. These are most conveniently connected between Pin 1 and Pin 2 for V_{DD1} and between Pin 15 and Pin 16 for V_{ISO} .

To suppress noise and reduce ripple, a parallel combination of at least two capacitors is required. The recommended capacitor values are 0.1 μF and 10 μF for V_{DD1} and V_{ISO} . The smaller capacitor must have a low ESR; for example, use of a ceramic capacitor is advised.

The total lead length between the ends of the low ESR capacitor and the input power supply pin must not exceed 2 mm. Installing the bypass capacitor with traces more than 2 mm in length may result in data corruption. Consider bypassing between Pin 1 and Pin 8 and between Pin 9 and Pin 16 unless both common ground pins are connected together close to the package.

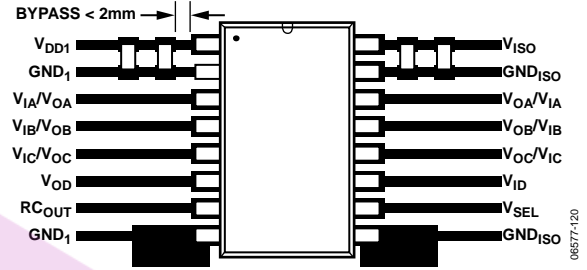

Figure 25. Recommended PCB Layout

In applications involving high common-mode transients, ensure that board coupling across the isolation barrier is minimized. Furthermore, design the board layout such that any coupling that does occur affects all pins equally on a given component side. Failure to ensure this can cause voltage differentials between pins exceeding the absolute maximum ratings for the device as specified in Table 19, thereby leading to latch-up and/or permanent damage.

The [ADuM5401/ADuM5402/ADuM5403/ADuM5404](#) are power devices that dissipate approximately 1 W of power when fully loaded and running at maximum speed. Because it is not possible to apply a heat sink to an isolation device, the devices primarily depend on heat dissipation into the PCB through the GND pins. If the devices are used at high ambient temperatures, provide a thermal path from the GND pins to the PCB ground plane. The board layout in Figure 25 shows enlarged pads for Pin 8 and Pin 9. Large diameter vias should be implemented from the pad to the ground, and power planes should be used to reduce inductance. Multiple vias should be implemented from the pad to the ground plane to significantly reduce the temperature inside the chip. The dimensions of the expanded pads are at the discretion of the designer and depend on the available board space.

THERMAL ANALYSIS

The [ADuM5401/ADuM5402/ADuM5403/ADuM5404](#) devices consist of four internal die attached to a split lead frame with two die attach paddles. For the purposes of thermal analysis, the die is treated as a thermal unit, with the highest junction temperature reflected in the θ_{JA} from Table 14. The value of θ_{JA} is based on measurements taken with the devices mounted on a JEDEC standard, 4-layer board with fine width traces and still air. Under normal operating conditions, the [ADuM5401/ADuM5402/ADuM5403/ADuM5404](#) devices operate at full load across the full temperature range without derating the output current. However, following the recommendations in the PCB Layout section decreases thermal resistance to the PCB, allowing increased thermal margins in high ambient temperatures.

PROPAGATION DELAY-RELATED PARAMETERS

Propagation delay is a parameter that describes the time it takes a logic signal to propagate through a component (see Figure 26). The propagation delay to a logic low output may differ from the propagation delay to a logic high.

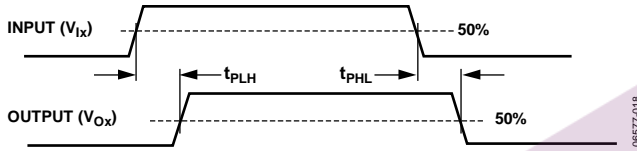

Figure 26. Propagation Delay Parameters

Pulse width distortion is the maximum difference between these two propagation delay values and is an indication of how accurately the input signal timing is preserved.

Channel-to-channel matching refers to the maximum amount the propagation delay differs between channels within a single ADuM5401/ADuM5402/ADuM5403/ADuM5404 component.

Propagation delay skew refers to the maximum amount the propagation delay differs between multiple ADuM5401/ADuM5402/ADuM5403/ADuM5404 components operating under the same conditions.

START-UP BEHAVIOR

The ADuM5401/ADuM5402/ADuM5403/ADuM5404 do not contain a soft start circuit. Therefore, the start-up current and voltage behavior must be taken into account when designing with this device.

When power is applied to V_{DD1} , the input switching circuit begins to operate and draw current when the UVLO minimum voltage is reached. The switching circuit drives the maximum available power to the output until it reaches the regulation voltage where PWM control begins. The amount of current and the time required to reach regulation voltage depends on the load and the V_{DD1} slew rate.

With a fast V_{DD1} slew rate (200 μ s or less), the peak current draws up to 100 mA/V of V_{DD1} . The input voltage goes high faster than the output can turn on, so the peak current is proportional to the maximum input voltage.

With a slow V_{DD1} slew rate (in the millisecond range), the input voltage is not changing quickly when V_{DD1} reaches the UVLO minimum voltage. The current surge is approximately 300 mA because V_{DD1} is nearly constant at the 2.7 V UVLO voltage. The behavior during startup is similar to when the device load is a short circuit; these values are consistent with the short-circuit current shown in Figure 14.

When starting the device for $V_{ISO} = 5$ V operation, do not limit the current available to the V_{DD1} power pin to less than 300 mA. The ADuM5401/ADuM5402/ADuM5403/ADuM5404 devices may not be able to drive the output to the regulation point if a current-limiting device clamps the V_{DD1} voltage during startup.

As a result, the ADuM5401/ADuM5402/ADuM5403/ADuM5404 devices can draw large amounts of current at low voltage for extended periods of time.

The output voltage of the ADuM5401/ADuM5402/ADuM5403/ADuM5404 devices exhibits V_{ISO} overshoot during startup. If this overshoot could potentially damage components attached to V_{ISO} , a voltage-limiting device such as a Zener diode can be used to clamp the voltage. Typical behavior is shown in Figure 19 and Figure 20.

EMI CONSIDERATIONS

The dc-to-dc converter section of the ADuM5401/ADuM5402/ADuM5403/ADuM5404 devices must operate at 180 MHz to allow efficient power transfer through the small transformers. This creates high frequency currents that can propagate in circuit board ground and power planes, causing edge emissions and dipole radiation between the primary and secondary ground planes. Grounded enclosures are recommended for applications that use these devices. If grounded enclosures are not possible, follow good RF design practices in the layout of the PCB. See the AN-0971 Application Note for board layout recommendations

DC CORRECTNESS AND MAGNETIC FIELD IMMUNITY

Positive and negative logic transitions at the isolator input cause narrow (~ 1 ns) pulses to be sent to the decoder via the transformer. The decoder is bistable and is, therefore, either set or reset by the pulses, indicating input logic transitions. In the absence of logic transitions at the input for more than 1 μ s, a periodic set of refresh pulses indicative of the correct input state is sent to ensure dc correctness at the output. If the decoder receives no internal pulses for more than approximately 5 μ s, the input side is assumed to be unpowered or nonfunctional, and the isolator output is forced to a default low state by the watchdog timer circuit. This situation should occur in the ADuM5401/ADuM5402/ADuM5403/ADuM5404 during power-up and power-down operations.

The limitation on the magnetic field immunity of the ADuM5401/ADuM5402/ADuM5403/ADuM5404 is set by the condition in which induced voltage in the receiving coil of the transformer is sufficiently large to either falsely set or reset the decoder. The following analysis defines the conditions under which this may occur. The 3.3 V operating condition of the ADuM5401/ADuM5402/ADuM5403/ADuM5404 is examined because it represents the most susceptible mode of operation.

The pulses at the transformer output have an amplitude greater than 1.0 V. The decoder has a sensing threshold at approximately 0.5 V, thus establishing a 0.5 V margin in which induced voltages can be tolerated. The voltage induced across the receiving coil is given by

$$V = (-d\beta/dt)\sum\pi r_n^2; n = 1, 2, \dots, N$$

where:

β is the magnetic flux density (gauss).

r_n is the radius of the n^{th} turn in the receiving coil (cm).

N is the total number of turns in the receiving coil.

Given the geometry of the receiving coil in the ADuM5401/ADuM5402/ADuM5403/ADuM5404, and an imposed requirement that the induced voltage be, at most, 50% of the 0.5 V margin at the decoder, a maximum allowable magnetic field is calculated as shown in Figure 27.

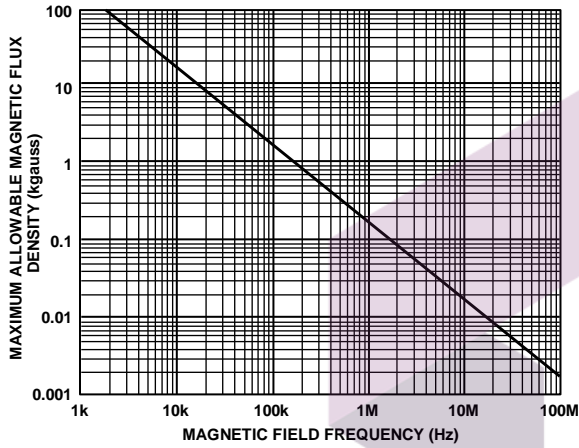

Figure 27. Maximum Allowable External Magnetic Flux Density

For example, at a magnetic field frequency of 1 MHz, the maximum allowable magnetic field of 0.2 kgauss induces a voltage of 0.25 V at the receiving coil. This voltage is approximately 50% of the sensing threshold and does not cause a faulty output transition. Similarly, if such an event occurs during a transmitted pulse (and is of the worst-case polarity), it reduces the received pulse from >1.0 V to 0.75 V, still well above the 0.5 V sensing threshold of the decoder.

The preceding magnetic flux density values correspond to specific current magnitudes at given distances from the ADuM5401/ADuM5402/ADuM5403/ADuM5404 transformers. Figure 28 expresses these allowable current magnitudes as a function of frequency for selected distances. As shown in Figure 28, the ADuM5401/ADuM5402/ADuM5403/ADuM5404 are extremely immune and can be affected only by extremely large currents operated at high frequency very close to the component. For the 1 MHz example, a 0.5 kA current placed 5 mm away from the ADuM5401/ADuM5402/ADuM5403/ADuM5404 is required to affect the operation of the device.

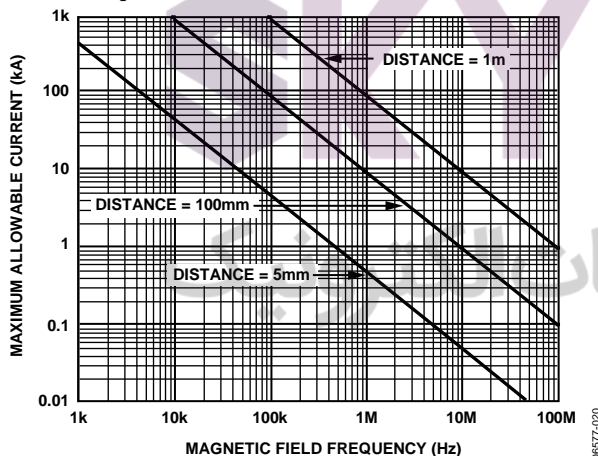

Figure 28. Maximum Allowable Current for Various Current-to-ADuM5401/ADuM5402/ADuM5403/ADuM5404 Spacings

Note that, at combinations of strong magnetic field and high frequency, any loops formed by PCB traces can induce error voltages sufficiently large to trigger the thresholds of succeeding circuitry. Exercise care in the layout of such traces to avoid this possibility.

POWER CONSUMPTION

The V_{DD1} power supply input provides power to the iCoupler data channels, as well as to the power converter. For this reason, the quiescent currents drawn by the data converter and the primary and secondary input/output channels cannot be determined separately. All of these quiescent power demands have been combined into the I_{DD1(Q)} current, as shown in Figure 29. The total I_{DD1} supply current is the sum of the quiescent operating current; the dynamic current, I_{DD1(D)}, demanded by the I/O channels; and any external I_{ISO} load.

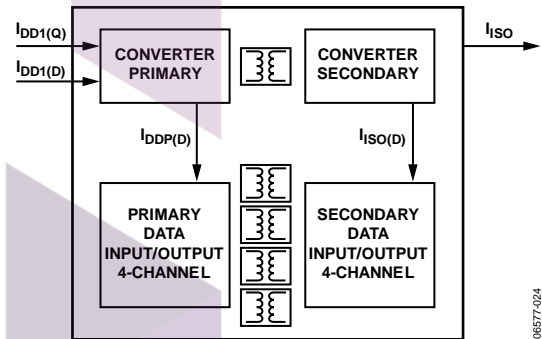

Figure 29. Power Consumption Within the ADuM5401/ADuM5402/ADuM5403/ADuM5404

Both dynamic input and output current is consumed only when operating at channel speeds higher than the refresh rate, f_r. Each channel has a dynamic current determined by its data rate. Figure 21 shows the current for a channel in the forward direction, which means that the input is on the primary side of the device. Figure 22 shows the current for a channel in the reverse direction, which means that the input is on the secondary side of the device. Both figures assume a typical 15 pF load. The following relationship allows the total I_{DD1} current to be calculated:

$$I_{DD1} = (I_{ISO} \times V_{ISO}) / (E \times V_{DD1}) + \sum I_{CHn}; n = 1 \text{ to } 4 \quad (1)$$

where:

I_{DD1} is the total supply input current.

I_{CHn} is the current drawn by a single channel determined from Figure 21 or Figure 22, depending on channel direction.

I_{ISO} is the current drawn by the secondary side external load.

E is the power supply efficiency at 100 mA load from Figure 11 at the V_{ISO} and V_{DD1} condition of interest.

The maximum external load can be calculated by subtracting the dynamic output load from the maximum allowable load.

$$I_{ISO(LOAD)} = I_{ISO(MAX)} - \sum I_{ISO(D)n}; n = 1 \text{ to } 4 \quad (2)$$

where:

$I_{ISO(LOAD)}$ is the current available to supply an external secondary side load.

$I_{ISO(MAX)}$ is the maximum external secondary side load current available at V_{ISO} .

$I_{ISO(D)n}$ is the dynamic load current drawn from V_{ISO} by an input or output channel, as shown in Figure 23 and Figure 24.

The preceding analysis assumes a 15 pF capacitive load on each data output. If the capacitive load is larger than 15 pF, the additional current must be included in the analysis of I_{DD1} and $I_{ISO(LOAD)}$.

POWER CONSIDERATIONS

The ADuM5401/ADuM5402/ADuM5403/ADuM5404 power input, data input channels on the primary side, and data channels on the secondary side are all protected from premature operation by undervoltage lockout (UVLO) circuitry. Below the minimum operating voltage, the power converter holds its oscillator inactive and all input channel drivers and refresh circuits are idle. Outputs remain in a high impedance state to prevent transmission of undefined states during power-up and power-down operations.

During application of power to V_{DD1} , the primary side circuitry is held idle until the UVLO preset voltage is reached. At that time, the data channels initialize to their default low output state until they receive data pulses from the secondary side.

When the primary side is above the UVLO threshold, the data input channels sample their inputs and begin sending encoded pulses to the inactive secondary output channels. The outputs on the primary side remain in their default low state because no data comes from the secondary side inputs until secondary side power is established. The primary side oscillator also begins to operate, transferring power to the secondary power circuits.

The secondary V_{ISO} voltage is below its UVLO limit at this point; the regulation control signal from the secondary side is not being generated. The primary side power oscillator is allowed to free run under these conditions, supplying the maximum amount of power to the secondary side.

As the secondary side voltage rises to its regulation setpoint, a large inrush current transient is present at V_{DD1} . When the regulation point is reached, the regulation control circuit produces the regulation control signal that modulates the oscillator on the primary side. The V_{DD1} current is then reduced and is proportional to the load current. The inrush current is less than the short-circuit current shown in Figure 14. The duration of the inrush current depends on the V_{ISO} loading conditions and on the current and voltage available at the V_{DD1} pin.

As the secondary side converter begins to accept power from the primary, the V_{ISO} voltage starts to rise. When the secondary side UVLO is reached, the secondary side outputs are initialized to their default low state until data is received from the corresponding primary side input. It can take up to 1 μ s after the secondary side is initialized for the state of the output to correlate to the primary side input.

Secondary side inputs sample their state and transmit it to the primary side. Outputs are valid about 1 μ s after the secondary side becomes active.

Because the rate of charge of the secondary side power supply is dependent on loading conditions, the input voltage, and the output voltage level selected, take care that the design allows the converter sufficient time to stabilize before valid data is required.

When power is removed from V_{DD1} , the primary side converter and coupler shut down when the UVLO level is reached. The secondary side stops receiving power and starts to discharge.

The outputs on the secondary side hold the last state that they received from the primary side. Either the UVLO level is reached and the outputs are placed in their high impedance state, or the outputs detect a lack of activity from the primary side inputs and the outputs are set to their default low value before the secondary power reaches UVLO.

INCREASING AVAILABLE POWER

The ADuM5401/ADuM5402/ADuM5403/ADuM5404 are designed with the capability of running in combination with other compatible *isoPower* devices. The RC_{OUT} pin allows the ADuM5401/ADuM5402/ADuM5403/ADuM5404 to provide its PWM signal to another device acting as a master to regulate its self and slave devices. Power outputs are combined in parallel while sharing output power equally.

The ADuM5401/ADuM5402/ADuM5403/ADuM5404 can only be a master/standalone, and the ADuM5200 can only be a slave/standalone device. The ADuM5000 can operate as either a master or slave. This means that the ADuM5000, ADuM520x, and ADuM540x can only be used in the master/slave combinations listed in Table 26.

Table 26. Allowed Combinations of *isoPower* Devices

| Master | Slave | | |
|----------|----------|----------|----------|
| | ADuM5000 | ADuM520x | ADuM540x |
| ADuM5000 | Yes | Yes | No |
| ADuM520x | No | No | No |
| ADuM540x | Yes | Yes | No |

The allowed combinations of master and slave configured devices listed in Table 26 is sufficient to make any combination of power and channel count.

Table 27 illustrates how *isoPower* devices can provide many combinations of data channel count and multiples of the single unit power.

Table 27. Configurations for Power and Data Channels

| Power Unit | Number of Data Channels | | | |
|--------------|---|---|---|---|
| | 0 Channels | 2 Channels | 4 Channels | 6 Channels |
| 1-Unit Power | ADuM5000 master | ADuM520x master | ADuM5401 to ADuM5404 master | ADuM5401 to ADuM5404 master ADuM121x |
| 2-Unit Power | ADuM5000 master ADuM5000 slave | ADuM5000 master ADuM520x slave | ADuM5401 to ADuM5404 master ADuM520x slave | ADuM5401 to ADuM5404 master ADuM520x slave |
| 3-Unit Power | ADuM5000 master ADuM5000 slave ADuM5000 slave | ADuM5000 master ADuM5000 slave ADuM520x slave | ADuM5401 to ADuM5404 master ADuM5000 slave ADuM5000 slave | ADuM5401 to ADuM5404 master ADuM520x slave ADuM5000 slave |

INSULATION LIFETIME

All insulation structures eventually break down when subjected to voltage stress over a sufficiently long period. The rate of insulation degradation is dependent on the characteristics of the voltage waveform applied across the insulation. In addition to the testing performed by the regulatory agencies, Analog Devices carries out an extensive set of evaluations to determine the lifetime of the insulation structure within the [ADuM5401/ADuM5402/ADuM5403/ADuM5404](#) devices.

Analog Devices performs accelerated life testing using voltage levels higher than the rated continuous working voltage. Acceleration factors for several operating conditions are determined. These factors allow calculation of the time to failure at the actual working voltage. The values shown in Table 20 summarize the peak voltage for 50 years of service life for a bipolar ac operating condition and the maximum CSA/VDE approved working voltages. In many cases, the approved working voltage is higher than the 50-year service life voltage. Operation at these high working voltages can lead to shortened insulation life in some cases.

The insulation lifetime of the [ADuM5401/ADuM5402/ADuM5403/ADuM5404](#) devices depends on the voltage waveform type imposed across the isolation barrier. The *iCoupler* insulation structure degrades at different rates depending on whether the waveform is bipolar ac, unipolar ac, or dc. Figure 30, Figure 31, and Figure 32 illustrate these different isolation voltage waveforms.

Bipolar ac voltage is the most stringent environment. The goal of a 50-year operating lifetime under the bipolar ac condition determines the maximum working voltage recommended by Analog Devices.

In the case of unipolar ac or dc voltage, the stress on the insulation is significantly lower. This allows operation at higher working voltages while still achieving a 50-year service life. The working voltages listed in Table 20 can be applied while maintaining the 50-year minimum lifetime, provided that the voltage conforms to either the unipolar ac or dc voltage cases.

Any cross-insulation voltage waveform that does not conform to Figure 31 or Figure 32 should be treated as a bipolar ac waveform and its peak voltage limited to the 50-year lifetime voltage value listed in Table 20.

The voltage presented in Figure 32 is shown as sinusoidal for illustration purposes only. It is meant to represent any voltage waveform varying between 0 V and some limiting value. The limiting value can be positive or negative, but the voltage cannot cross 0 V.

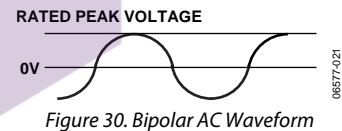

Figure 30. Bipolar AC Waveform

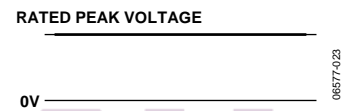

Figure 31. DC Waveform

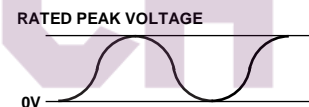

Figure 32. Unipolar AC Waveform

NOTES:

1. THE VOLTAGE IS SHOWN AS SINUSOIDAL FOR ILLUSTRATION PURPOSES ONLY. IT IS MEANT TO REPRESENT ANY VOLTAGE WAVEFORM VARYING BETWEEN 0V AND SOME LIMITING VALUE. THE LIMITING VALUE CAN BE POSITIVE OR NEGATIVE, BUT THE VOLTAGE CANNOT CROSS 0V.

06577-022

OUTLINE DIMENSIONS

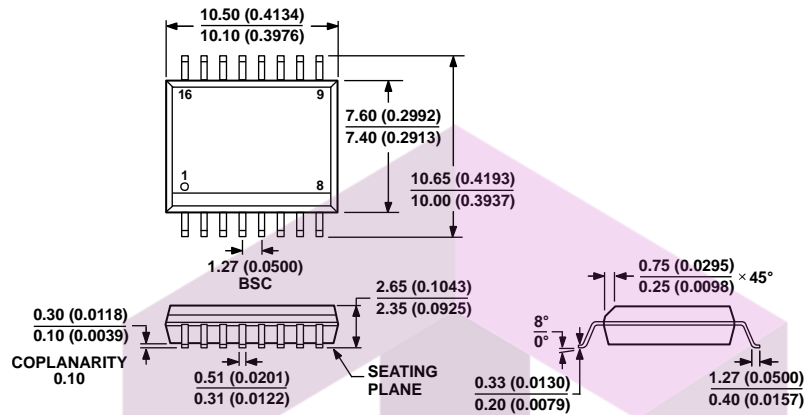

COMPLIANT TO JEDEC STANDARDS MS-013-AA
 CONTROLLING DIMENSIONS ARE IN MILLIMETERS; INCH DIMENSIONS
 (IN PARENTHESES) ARE ROUNDED-OFF MILLIMETER EQUIVALENTS FOR
 REFERENCE ONLY AND ARE NOT APPROPRIATE FOR USE IN DESIGN.

Figure 33. 16-Lead Standard Small Outline Package [SOIC_W]
 Wide Body
 (RW-16)

Dimensions shown in millimeters and (inches)

03-27-2007-B

ORDERING GUIDE

| Model ^{1,2} | Number of Inputs, V _{DD1} Side | Number of Inputs, V _{ISO} Side | Maximum Data Rate (Mbps) | Maximum Propagation Delay, 5 V (ns) | Maximum Pulse Width Distortion (ns) | Temperature Range (°C) | Package Description | Package Option |
|----------------------|---|---|--------------------------|-------------------------------------|-------------------------------------|------------------------|---------------------|----------------|
| ADuM5401ARWZ | 3 | 1 | 1 | 100 | 40 | -40 to +105 | 16-Lead SOIC_W | RW-16 |
| ADuM5401CRWZ | 3 | 1 | 25 | 60 | 6 | -40 to +105 | 16-Lead SOIC_W | RW-16 |
| ADuM5402ARWZ | 2 | 2 | 1 | 100 | 40 | -40 to +105 | 16-Lead SOIC_W | RW-16 |
| ADuM5402CRWZ | 2 | 2 | 25 | 60 | 6 | -40 to +105 | 16-Lead SOIC_W | RW-16 |
| ADuM5403ARWZ | 1 | 3 | 1 | 100 | 40 | -40 to +105 | 16-Lead SOIC_W | RW-16 |
| ADuM5403CRWZ | 1 | 3 | 25 | 60 | 6 | -40 to +105 | 16-Lead SOIC_W | RW-16 |
| ADuM5404ARWZ | 0 | 4 | 1 | 100 | 40 | -40 to +105 | 16-Lead SOIC_W | RW-16 |
| ADuM5404CRWZ | 0 | 4 | 25 | 60 | 6 | -40 to +105 | 16-Lead SOIC_W | RW-16 |

¹ Z = RoHS Compliant Part.

² Tape and reel are available. The addition of an RL suffix designates a 13" (1,000 units) tape and reel option.



تهیه و توزیع قطعات الکترونیک

NOTES



SKYTECH

تهيئه وتوزيع قطعات الكترولنيك

NOTES



SKYTECH

تهیه و توزیع قطعات الکترونیک